

# CANEO

## Original Operating Instructions



IO-Link

series10 standard

### Technical specifications

Operating voltage	DC 24 V (8.4...32 V)
Load current	max. 200 mA
Output	Adjustable PNP / NPN; NO / NC
Output pulse	Adjustable
Reverse polarity protection	Protection of all cables/lines
Short circuit protection	Protected against short circuit and overload
Voltage drop	Max. 5 V at 200 mA load current
Power consumption at 24 V	Max. 40 mA
Operating temperature	-30 °C (-22 °F)...+65 °C (149 °F)
Degree of protection IP	Front IP69K
Degree of protection IK	IK08
Communications interface	IO-Link specification V1.1
Type of actuation	Capacitive
Actuation force	No actuation force required
Max. altitude	2000 m above sea level with "CSA" listing"
Relative air humidity	Max. 95%, non-condensing

### Drilling pattern

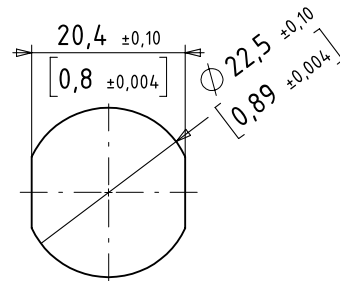

The SENSORswitch is secured against rotation by the illustrated hole.

Metric and imperial measurements are used in drawings. Imperial measurements are marked with [ ].

### Connection options

#### Plug M12, 3-pin

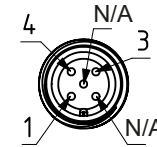

#### Plug M12, 4-pin

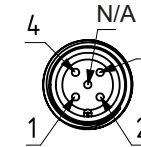

#### Plug M12, 5-pin

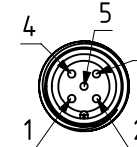

### Connection plan

3-pin

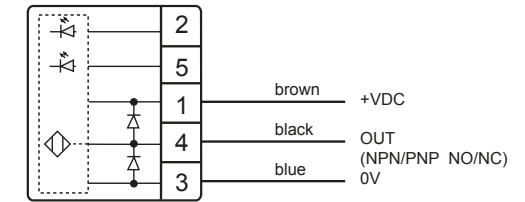

The product description will indicate the configuration.

4-pin

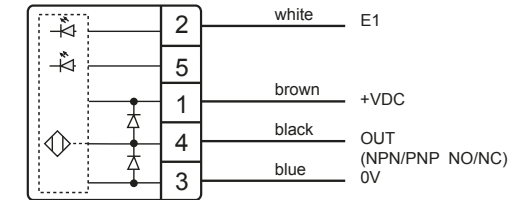

The product description will indicate the configuration.

### Safety

#### General safety

All work on electrical systems or operating equipment may only be carried out by a specially qualified electrician according to the applicable electrotechnical regulations.

The safety of the system in which the SENSORswitch is integrated is the responsibility of the operator.



#### Improper work on electrical systems!

- Electric shock can result in death or life-threatening injuries.
- Before working on electrical systems, disconnect them from their voltage supply and secure them against being switched on again.
- Wear appropriate personal protective equipment (PPE).

#### Intended use

The SENSORswitch is intended for use in accordance with the items listed here, the values from the "Technical specifications" chapter and the product description.

- Only connect the product to a limited energy source as per IEC 61010 or an NEC class 2 power supply unit.
- Source current < 4 A at maximum operating voltage.

#### Reasonably foreseeable misuse

Any use other than as specified in the section **Intended use** or extending beyond this is deemed to be improper.

The SENSORswitch is not suitable for:

- use in potentially explosive atmospheres.
- use as a safety component as per directive 2006/42/EC

### Foreword

This manual has been written for technicians/installers and operators and should be kept for future reference. Read these operating instructions carefully and make sure that you have fully understood the contents before installing or working with the SENSORswitches.

### General description

The supplied SENSORswitch can have options that differ from those shown in this manual. This does not affect the function. The SENSORswitch is equipped with an RGB-LED to indicate the operating conditions. The RGB-LED is controlled variably, depending on the configuration.

A	SENSORswitch
B	Connection M12
C	Lock nut

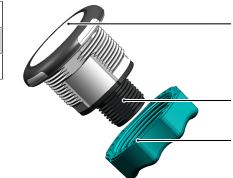

### Assembly

Requirements: Mounting surface is level and clean.

- Disconnect the system from its voltage supply and secure it against being switched on again.
- Set the desired position of the SENSORswitch and drill the hole according to the drilling pattern.
- Insert SENSORswitch (A) into the prepared hole and screw the lock nut (C) on.
- Position the SENSORswitch (A) and tighten the lock nuts with max. 1.5 Nm.
- Connect SENSORswitch (A) electrically to terminal (B) according to the connection plan.

### 5-pin

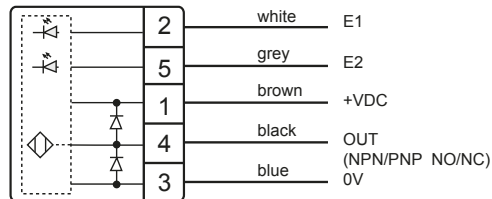

The product description will indicate the configuration.

### Dimensional drawing

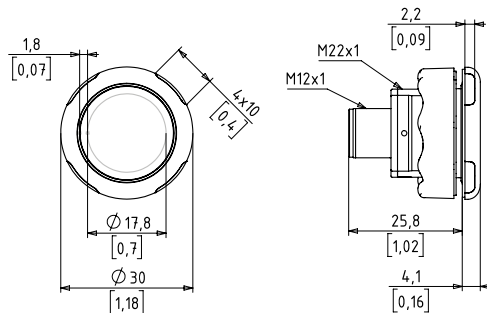

Metric and imperial measurements are used in drawings. Imperial measurements are marked with [ ].

### Configure CANEO series10 with IO-Link

#### TIP

For information on configuring the SENSORswitch, see our website [series10.captron.com](http://series10.captron.com) or scan the QR code.



### Maintenance

#### Maintenance operations

Carry out the following maintenance operations at the specified intervals.

Maintenance operation	as needed	annually
Clean the button surface	X	
Check cables for intactness and firm fit		X
Check screw connections for tightness		X

#### NOTICE

Solvents contained in cleaning agents can attack the plastic of the button!

- Clean the surface of the button with a neutral cleaning agent or a damp microfiber cloth.

### Disassembly

- Disconnect the system from its voltage supply and secure it against being switched on again.
- Disconnect the electrical connection and remove the lock nuts.

### Disposal

Electrical and electronic components of various types must be recycled according to their type.

## **Imprint**

The operating instructions have been authored and published by

CAPTRON Electronic GmbH

Johann-G.-Gutenberg-Straße 7

82140 Olching – Germany

Tel.: +49 (0)8142 - 44 88 - 160

[sales@captron.com](mailto:sales@captron.com)

[www.captron.com](http://www.captron.com)

Copyright 2019

CANEO series10 1.1